

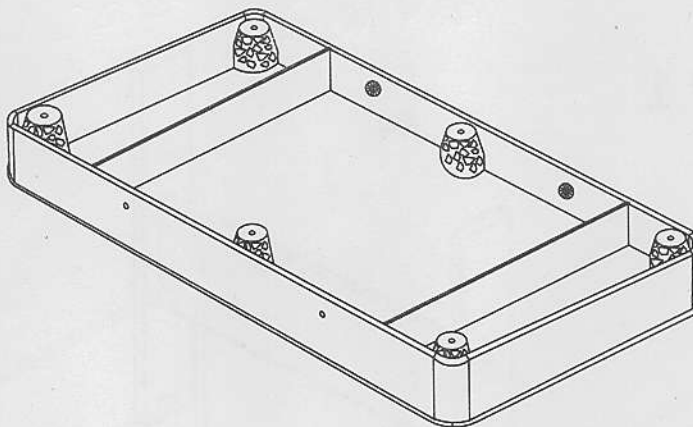











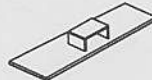



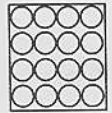

TEAM 1
55.909.05.2

Part List

#1



<p>#2</p>  <p>Leg (A) 2PCS</p>	<p>#3</p>  <p>Leg (B) 2PCS</p>	<p>#4</p>  <p>Leg Panels (A) 2PCS</p>	<p>#5</p>  <p>Leg Panels (B) 1PC</p>	<p>#6</p>  <p>5/16**3" Plastic Blots 4PCS</p>
<p>#7</p>  <p>5/16**19mm Washers 4PCS</p>	<p>#8</p>  <p>8**2" Screws 12PCS</p>	<p>#9</p>  <p>48" Cues 2PCS</p>	<p>#10</p>  <p>1-3/4"Triangle 1PC</p>	<p>#11</p>  <p>Chalks 2PCS</p>
<p>#12</p>  <p>Brush 1PC</p>	<p>#13</p>  <p>1-3/4" Pool Balls 1SET</p>	<p>#14</p>  <p>5*12mm Washer 4PCS</p>	<p>#15</p>  <p>Plastic Cover 4PCS</p>	<p>#16</p>  <p>Steel Bolts 2PCS</p>
<p>#17</p>  <p>Wheels 4PCS</p>	<p>#18</p>  <p>T5*10mm Screws 4PCS</p>			

STEP 2

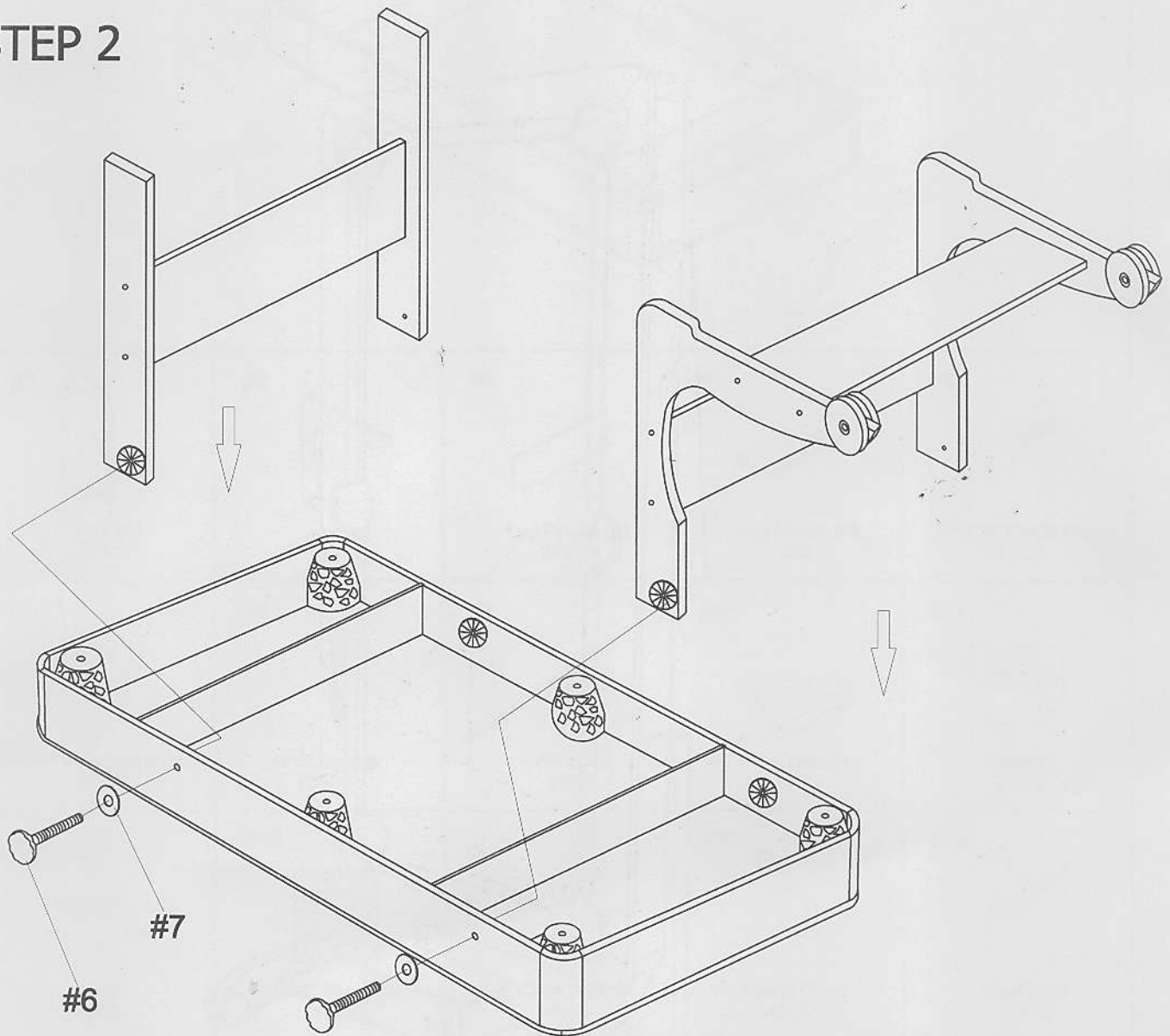

STEP 2

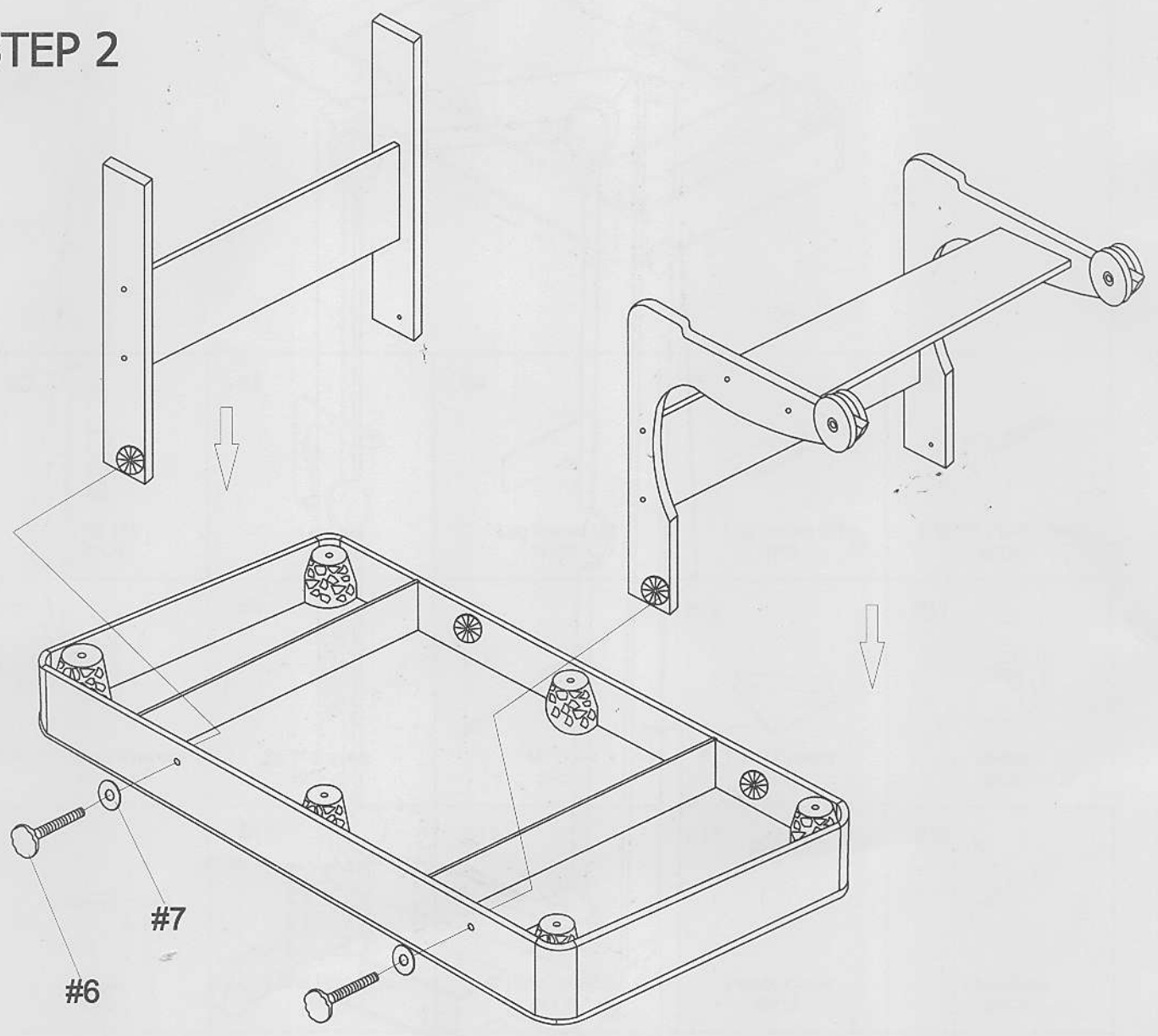

STEP 3

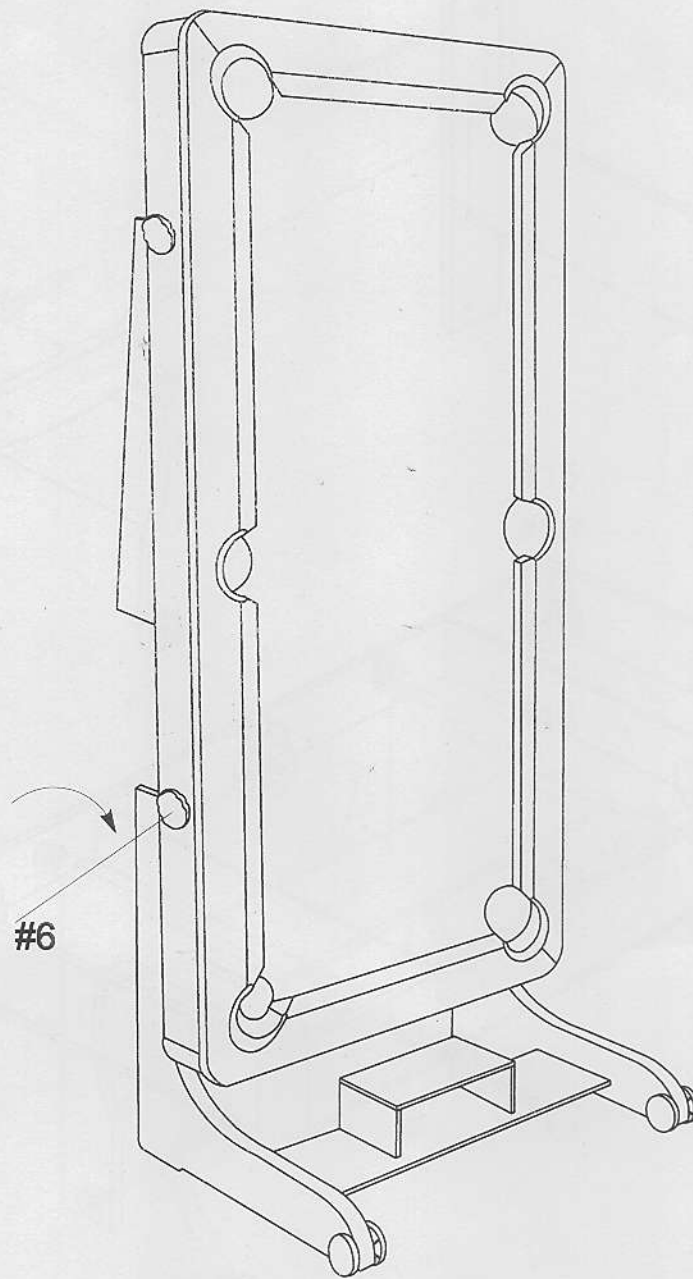

Please fold the #6 tightened